

FACILE series FC85A FC120A

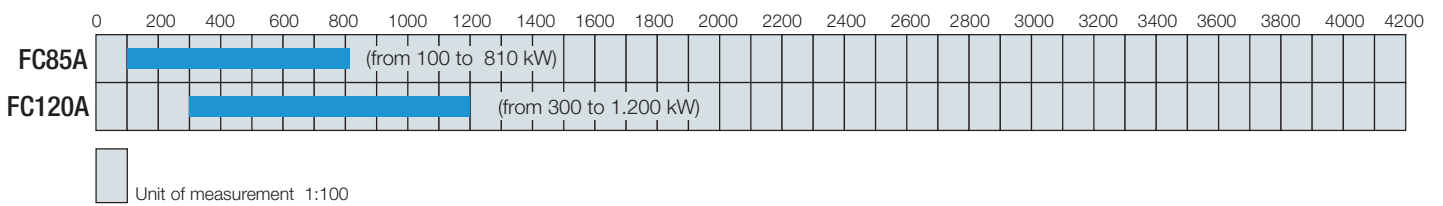

SMART BURNER - new generation
 Low NO_x gas burner - Class 2 EN676

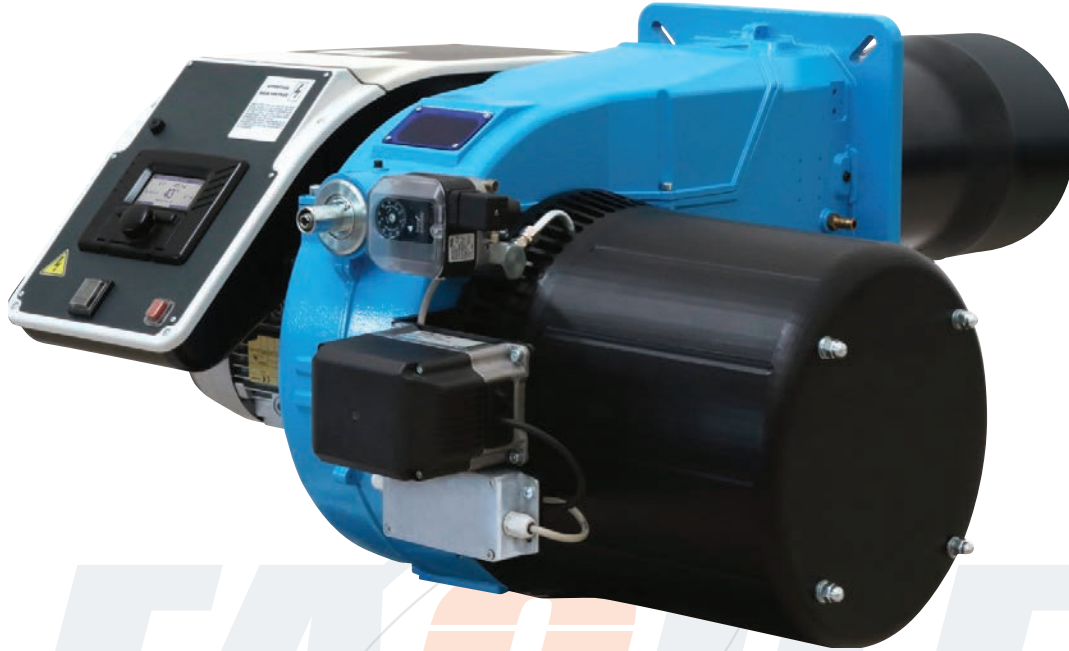

AUTOMATIC COMMISSIONING
 IN JUST A FEW MINUTES



ADAPTS THE BURNER TO
 ALL HEAT GENERATORS
 AND PROCESS



AUTOMATICALLY ADJUSTS
 ENVIRONMENTAL VALUES



CONSTANT AND COMPLETE
 MONITORING ON VARIOUS LEVELS



GUARANTEES REGULATORY
 COMPLIANCE



ECONOMICALLY SUSTAINABLE,
 RETURN ON INVESTMENT IN THE
 SHORT-TO-MEDIUM TERM

CIB UNIGAS
 The Smart Combustion

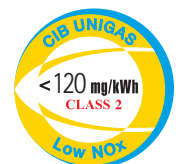

Burner with emissions
 below 120 mg kWh

TECHNICAL CHARACTERISTICS

| Model | | Power kW | | Electrical power supply | Fan motor kW | Gas fittings | Noise level dBA |
|---------------|---------------------|----------|-------|-------------------------|--------------|------------------------|-----------------|
| | | min. | max. | | | | |
| FC85A | M-.xx.xR.IT.A.1.xxx | 100 | 810 | 230/400 V 3N ac | 1,1 | 1"¼ - 1"½ - 2" - DN65 | < 85 |
| FC120A | M-.xx.xR.IT.A.1.xxx | 300 | 1.200 | 230/400 V 3N ac | 1,5 | 1"½ - 2" - DN65 - DN80 | < 85 |

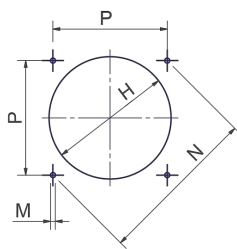
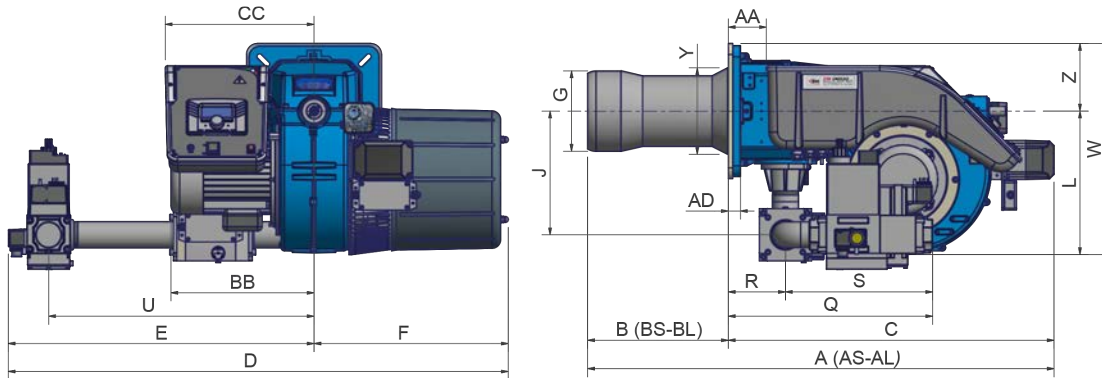

Recommended boiler hole

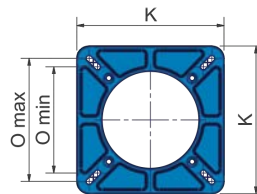

Burner flange

| Model | Dimensions of packaging (mm) | | | |
|---------------|------------------------------|---|---|----|
| | l | p | h | kg |
| FC85A | - | - | - | - |
| FC120A | - | - | - | - |

Indicative values

| Model | Overall dimensions (mm) | | | | | | | | | | | | | | | | | | | | | | | | | | | | | |
|---------------|-------------------------|----|------|------|------|-----|-----|-----|-----|------|-----|-----|-----|-----|-----|-----|-----|-----|-----|-----|-----|-----|-----|-----|-----|-----|-----|-----|-----|-----|
| | AA | AS | AL | BB | BS | BL | C | CC | D | E | F | G | H | J | K | L | M | N | O | | P | Q | R | S | U | V | W | Y | Z | |
| | | | min. | | max. | | | | | | | | | | | | | | | | | | | | | | | | | |
| FC85A | M-.xx.xR.IT.A.1.32 | 87 | 1050 | 1140 | 328 | 320 | 410 | 730 | 342 | 1332 | 889 | 425 | 184 | 218 | 275 | 300 | 329 | M10 | 330 | 216 | 250 | 233 | 575 | 131 | 444 | 796 | - | 484 | 198 | 155 |
| FC85A | M-.xx.xR.IT.A.1.40 | 87 | 1050 | 1140 | 328 | 320 | 410 | 730 | 342 | 1332 | 889 | 425 | 184 | 218 | 275 | 300 | 329 | M10 | 330 | 216 | 250 | 233 | 610 | 131 | 479 | 796 | - | 484 | 198 | 155 |
| FC85A | M-.xx.xR.IT.A.1.50 | 87 | 1050 | 1140 | 328 | 320 | 410 | 730 | 342 | 1332 | 889 | 425 | 184 | 218 | 275 | 300 | 329 | M10 | 330 | 216 | 250 | 233 | 610 | 131 | 479 | 796 | - | 484 | 198 | 155 |
| FC85A | M-.xx.xR.IT.A.1.65 | 87 | 1050 | 1140 | 328 | 320 | 410 | 730 | 342 | 1364 | 921 | 425 | 184 | 218 | 340 | 300 | 329 | M10 | 330 | 216 | 250 | 233 | 525 | 131 | 396 | 796 | 292 | 484 | 198 | 155 |
| FC120A | M-.xx.xR.IT.A.1.40 | 87 | 1110 | 1220 | 345 | 380 | 490 | 730 | 345 | 1332 | 889 | 425 | 234 | 264 | 275 | 300 | 329 | M10 | 330 | 216 | 250 | 233 | 610 | 131 | 479 | 796 | - | 484 | 198 | 155 |
| FC120A | M-.xx.xR.IT.A.1.50 | 87 | 1110 | 1220 | 345 | 380 | 490 | 730 | 345 | 1332 | 889 | 425 | 234 | 264 | 275 | 300 | 329 | M10 | 330 | 216 | 250 | 233 | 610 | 131 | 479 | 796 | - | 484 | 198 | 155 |
| FC120A | M-.xx.xR.IT.A.1.65 | 87 | 1110 | 1220 | 345 | 380 | 490 | 730 | 345 | 1364 | 921 | 425 | 234 | 264 | 340 | 300 | 329 | M10 | 330 | 216 | 250 | 233 | 525 | 131 | 394 | 796 | 292 | 484 | 198 | 155 |
| FC120A | M-.xx.xR.IT.A.1.80 | 87 | 1110 | 1220 | 345 | 380 | 490 | 730 | 345 | 1309 | 866 | 425 | 234 | 264 | 340 | 300 | 329 | M10 | 330 | 216 | 250 | 233 | 641 | 131 | 510 | 746 | 310 | 484 | 198 | 155 |

Indicative values



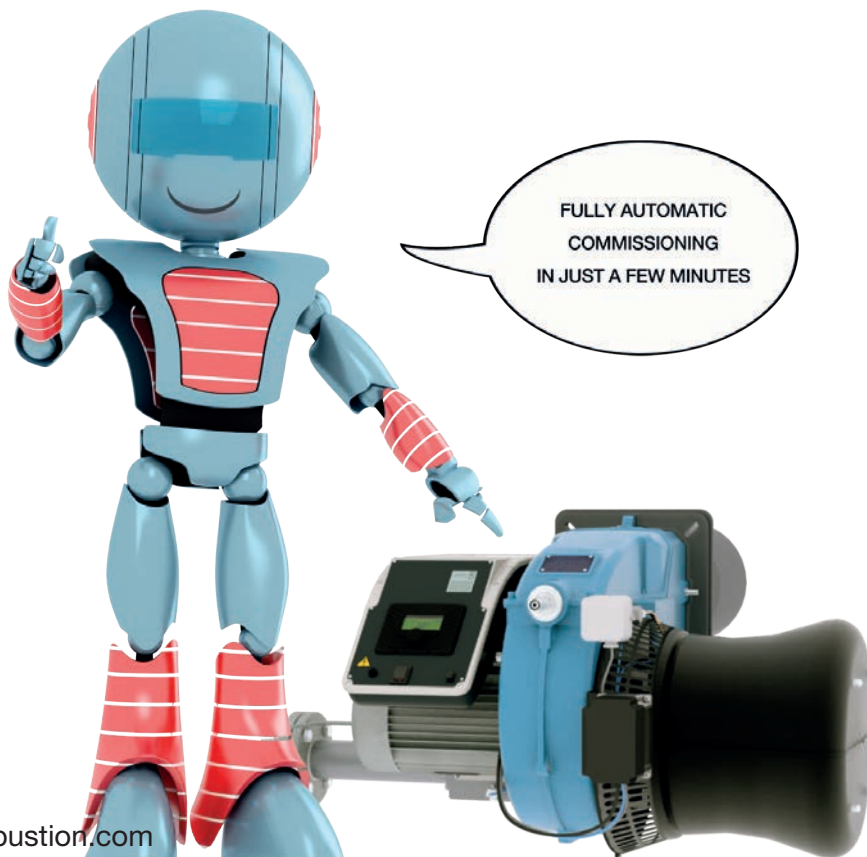
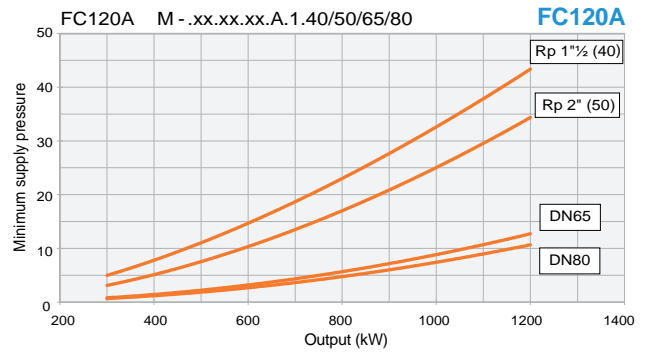
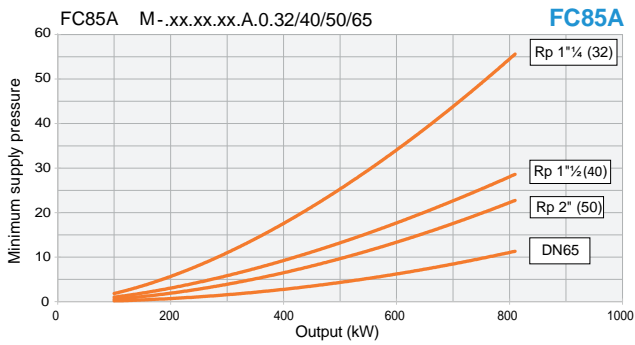
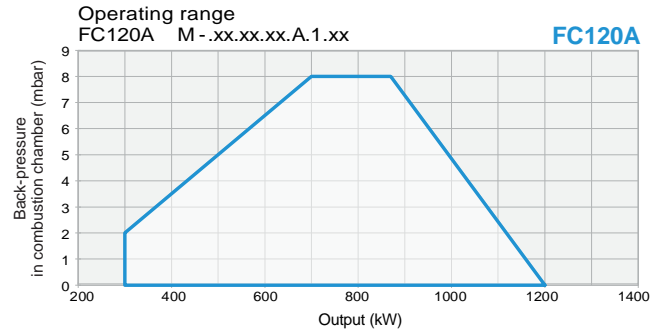
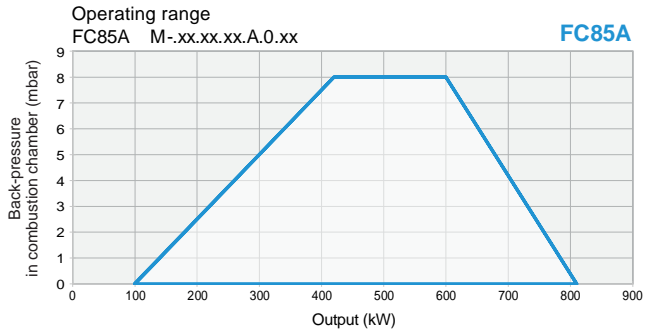

FULLY AUTOMATIC
COMMISSIONING
IN JUST A FEW MINUTES

LOW NO_x GAS BURNER RANGE

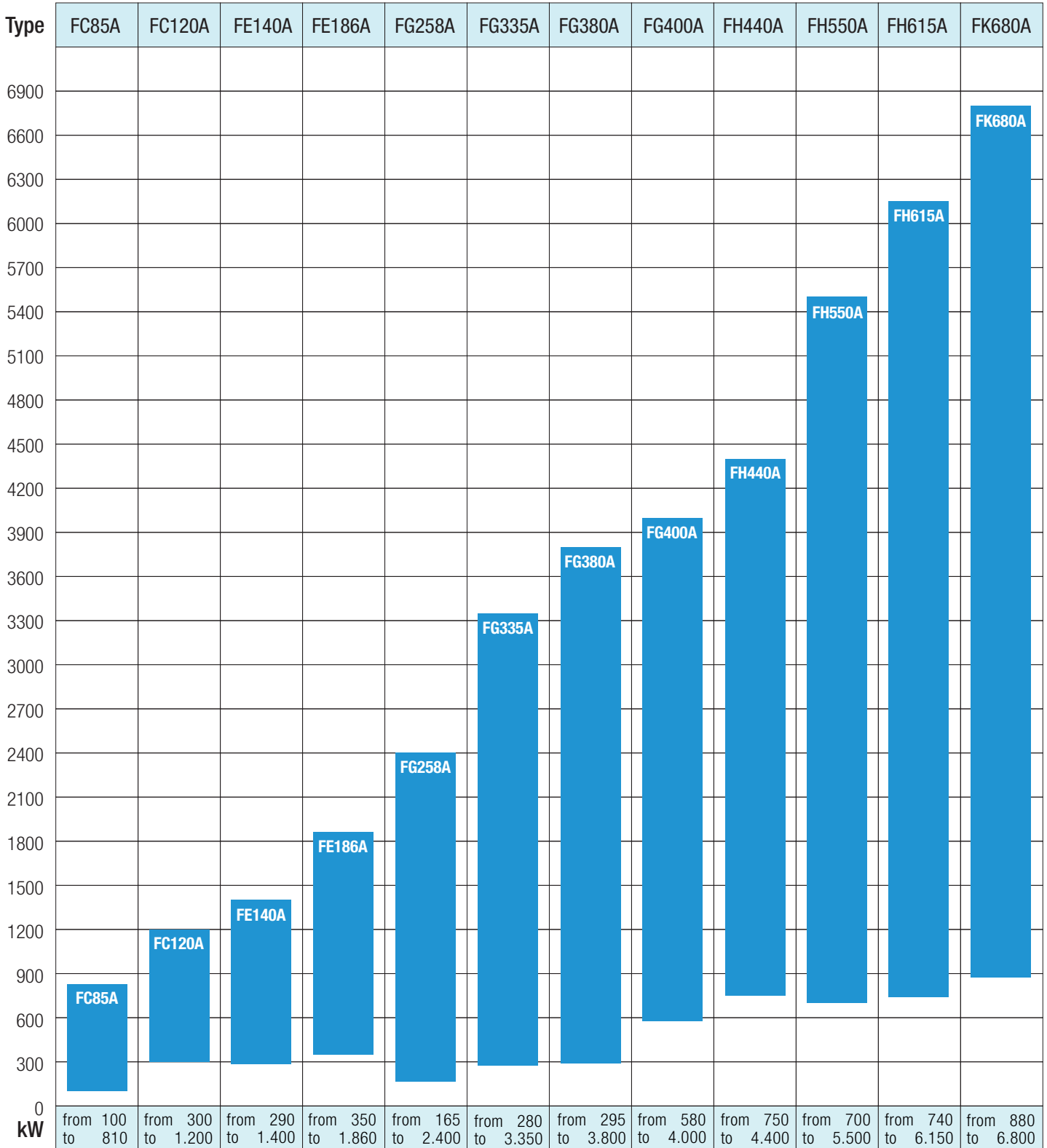

Unit of measurement 1:300



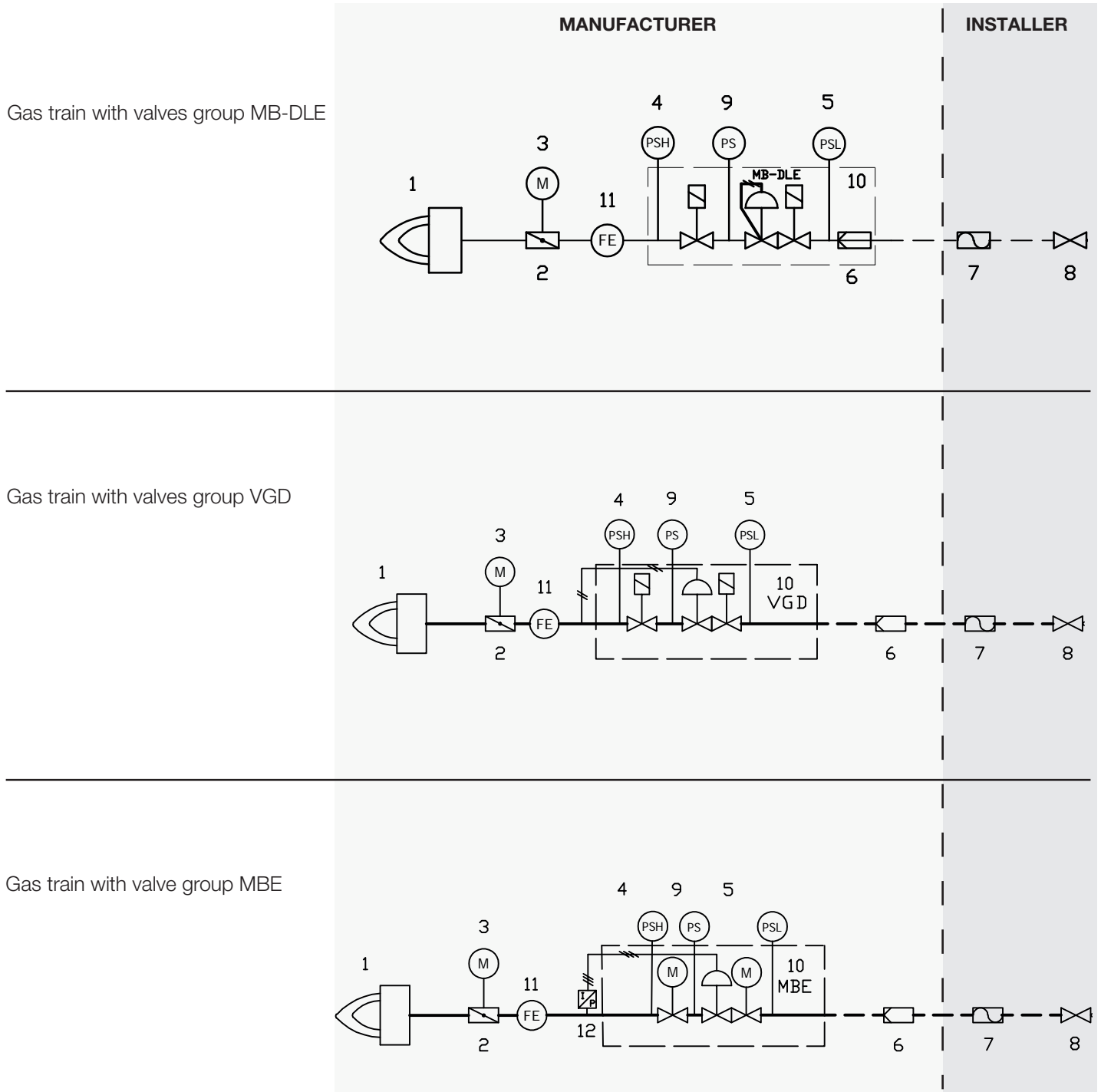

LEGEND

- | | |
|--|------------------------------------|
| 1 Burner | 7 Anti-vibration joint |
| 2 Butterfly valve | 8 Manual gas shut-off valve |
| 3 Servocontrol | 9 Leak control gas pressure switch |
| 4 Maximum gas pressure switch (optional) | 10 Valve group |
| 5 Minimum gas pressure switch | 11 Flow sensor |
| 6 Gas filter | 12 MBE valves pressure sensor |

