

FACILE series FRX2050

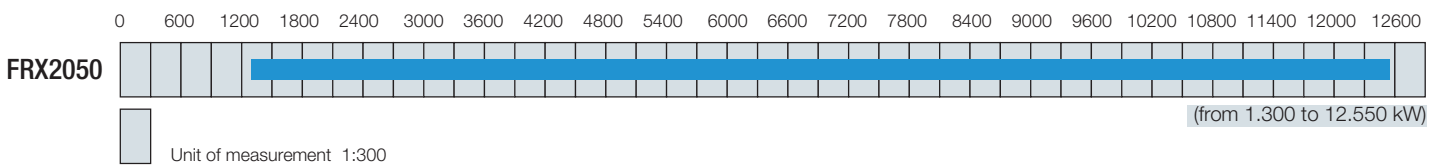

SMART BURNER - new generation
 Low NO_x gas burner - Class 3 EN676



AUTOMATIC COMMISSIONING
 IN JUST A FEW MINUTES



ADAPTS THE BURNER TO
 ALL HEAT GENERATORS
 AND PROCESS



AUTOMATICALLY ADJUSTS
 ENVIRONMENTAL VALUES



CONSTANT AND COMPLETE
 MONITORING ON VARIOUS LEVELS



GUARANTEES REGULATORY
 COMPLIANCE



ECONOMICALLY SUSTAINABLE,
 RETURN ON INVESTMENT IN THE
 SHORT-TO-MEDIUM TERM



TECHNICAL CHARACTERISTICS

Model		Power kW		Electrical power supply	Fan motor kW	Gas fittings	Noise level d BA
		min.	max.				
FRX2050	M-.xx.xR.IT.A.1.xxx	1.300	12.550	230/400 V 3N ac	37	DN80 - DN100 - DN125	< 92.5

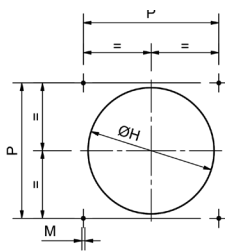
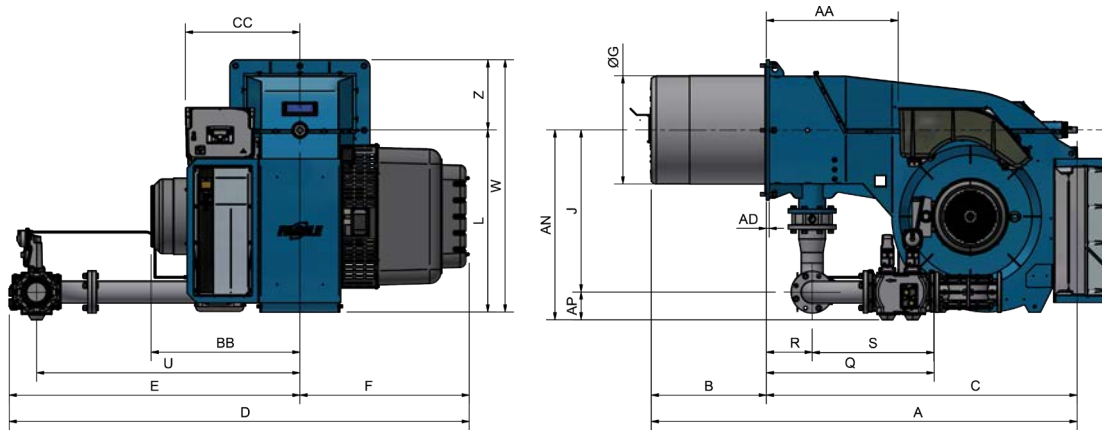

Recommended boiler hole

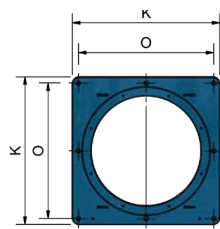

Burner flange

Model	Dimensions of packaging (mm)			
	l	p	h	kg
FRX2050	3.300	2.180	2.040	-

Indicative values

Model	Overall dimensions (mm)																													
	AA	AD	AS	AL	BB	BS	BL	C	CC	D	E	F	G	H	J	K	L	M	N	O	P	Q	R	S	U	V	W	Z		
											min. max.																			
FRX2050	M-.xx.xR.IT.A.1.80	690	15	2230	-	770	600	-	1630	600	2385	1500	885	564	624	845	730	950	M16	948	710	710	670	975	240	735	1375	310	1315	365
FRX2050	M-.xx.xR.IT.A.1.100	690	15	2230	-	770	600	-	1630	600	2385	1500	885	564	624	845	730	950	M16	948	710	710	670	880	240	640	1375	346	1315	365
FRX2050	M-.xx.xR.IT.A.1.125	690	15	2230	-	770	600	-	1630	600	2385	1500	885	564	624	845	730	950	M16	948	710	710	670	1100	240	860	1375	480	1315	365

Indicative values

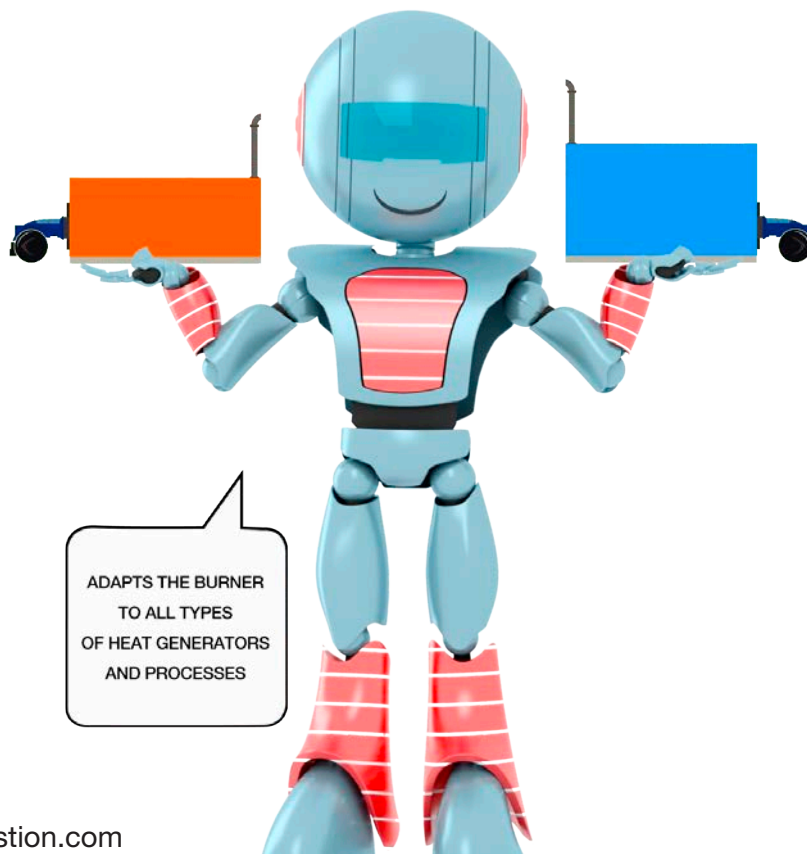
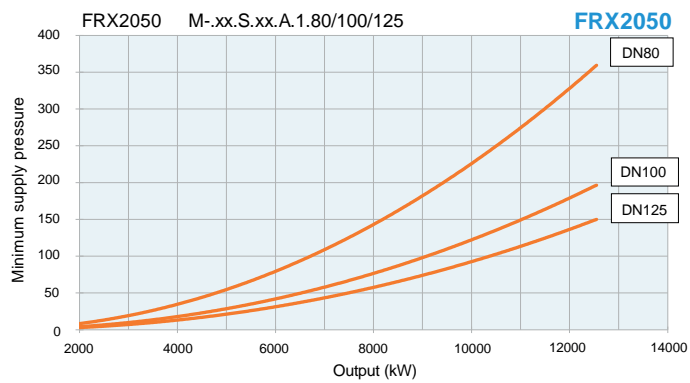
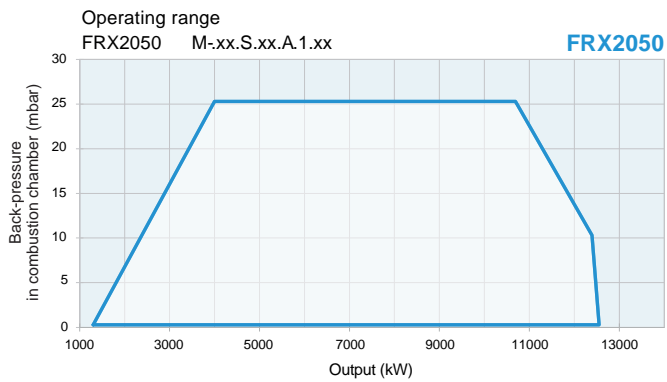

LOW NO_x GAS BURNER RANGE

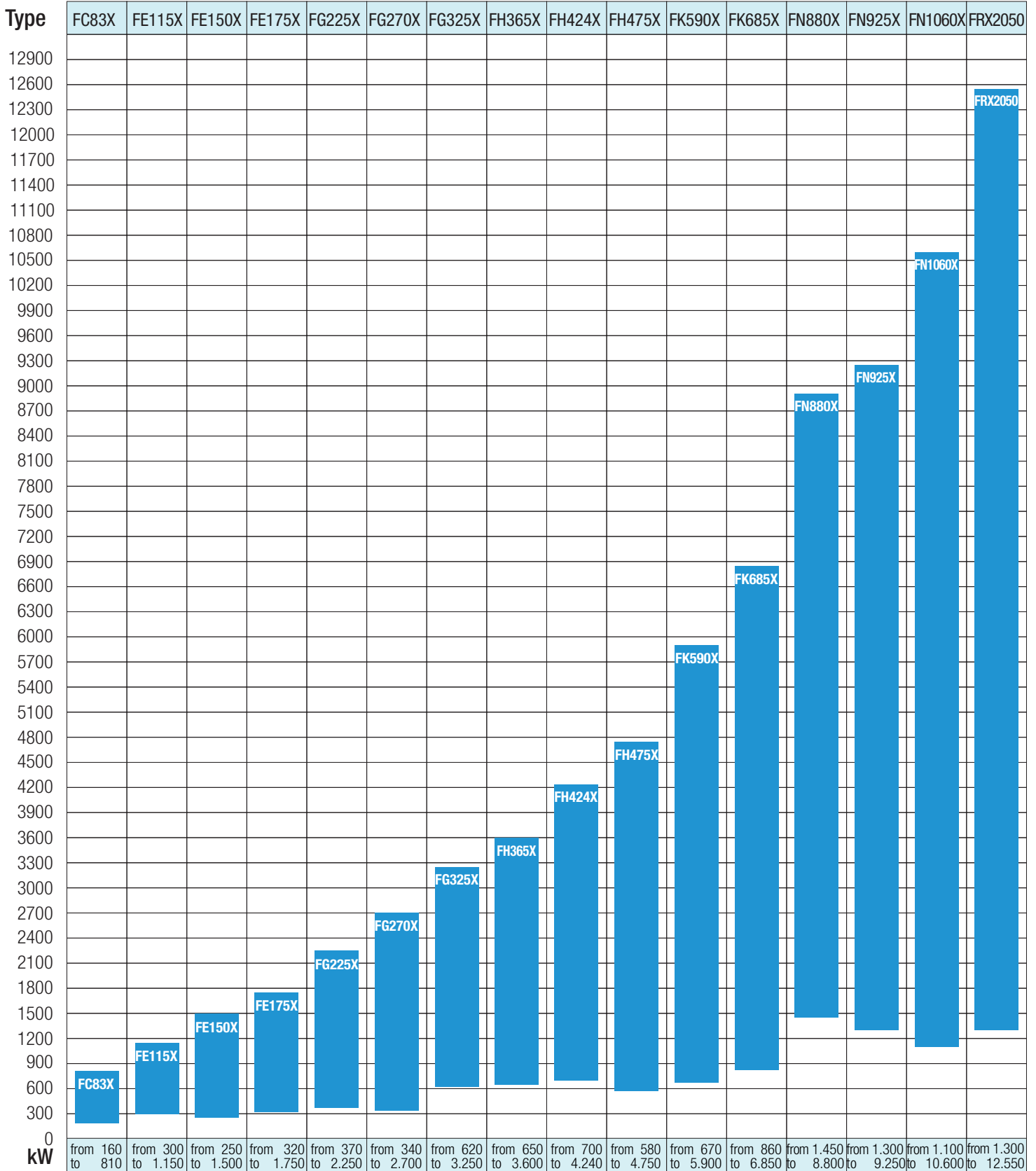

Unit of measurement 1:300



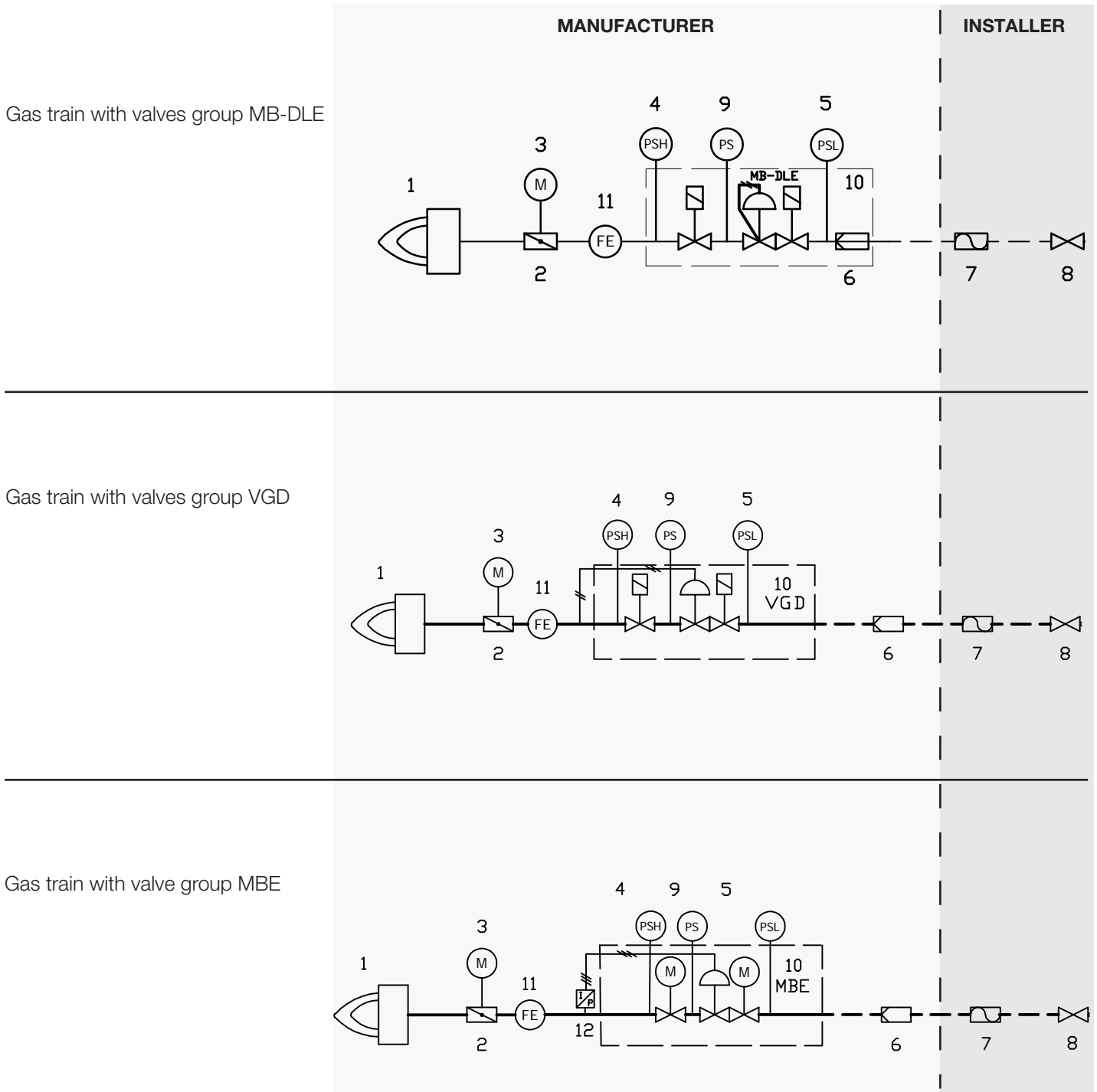

LEGEND

- | | |
|--|------------------------------------|
| 1 Burner | 7 Anti-vibration joint |
| 2 Butterfly valve | 8 Manual gas shut-off valve |
| 3 Servocontrol | 9 Leak control gas pressure switch |
| 4 Maximum gas pressure switch (optional) | 10 Valve group |
| 5 Minimum gas pressure switch | 11 Flow sensor |
| 6 Gas filter | 12 MBE valves pressure sensor |

